

DESIGN  
NATALINO MALASORTI



**CRX23/CROSS**  
AISI 316L STAINLESS STEEL

Gruppo 2 miscelatori idroprogressivi  
vasca con bocca di erogazione e  
doccino

Set of 2 hydroprogressive mixers for  
bathtub with spout and hand shower



## PRODOTTI CORRELATI / RELATED PRODUCTS

FRE74 - MIL91



Rompi-getto, utilizzabile per il riempimento vasca  
*Flow straightener, suitable for bathtub*



Prodotto che necessita di parte incasso  
*Product that needs built-in part*



Staffa ausiliaria per cartongesso / fibrogesso  
*Auxiliary bracket for plasterboard / fiber-board structures*

## MANUTENZIONE / MAINTENANCE

NON UTILIZZARE DO NOT USE		acido clorico e muriatico <i>chloric and muriatic acid</i>
		acido fluoridrico <i>hydrofluoric acid</i>
		ipoclorito di sodio <i>chlorine bleach</i>
UTILIZZARE TO USE		sapone a PH neutro <i>neutral PH soap</i>

Questi disegni sono proprietà di CEADDESIGN SRL s.u. pertanto non potranno essere utilizzati e/o comunicati a terzi, anche in forma parziale, senza preventiva autorizzazione. CEADDESIGN SRL s.u. si riserva il diritto di apportare modifiche ai disegni al fine di migliorare il prodotto.

CEADDESIGN SRL s.u. has the property rights on these drawings, therefore they cannot be used and/or transferred to third party, even in partial form, without any prior authorization. Furthermore CEADDESIGN SRL s.u. reserves the right to apply any change to these drawings in order to upgrade the product.

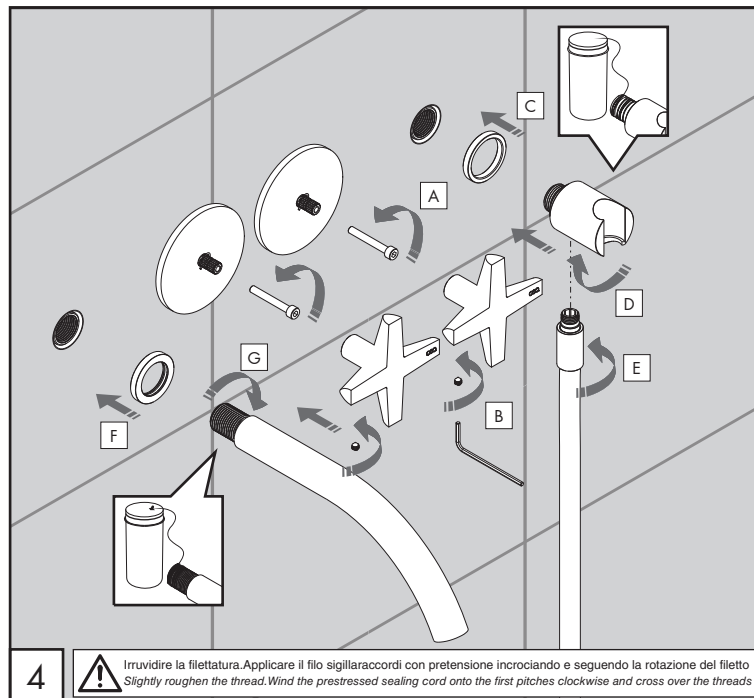
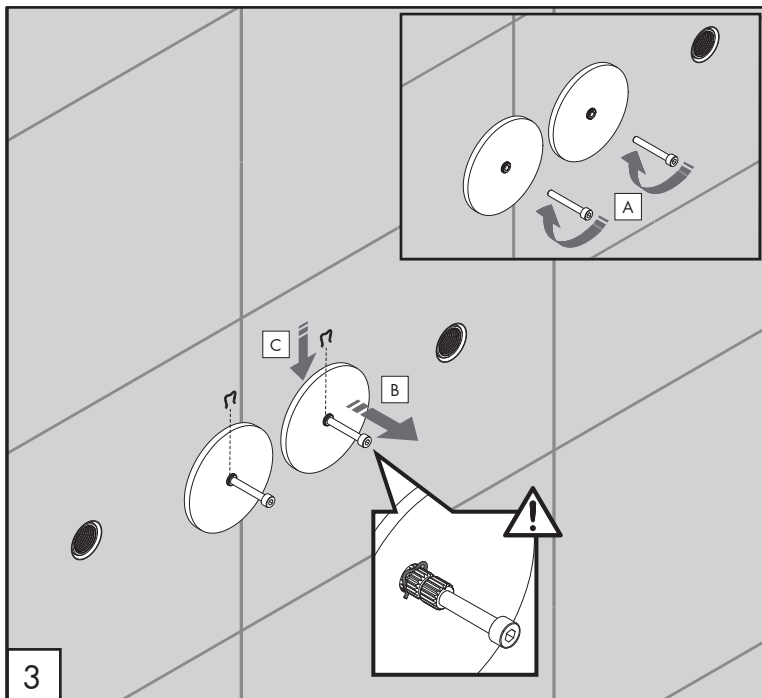
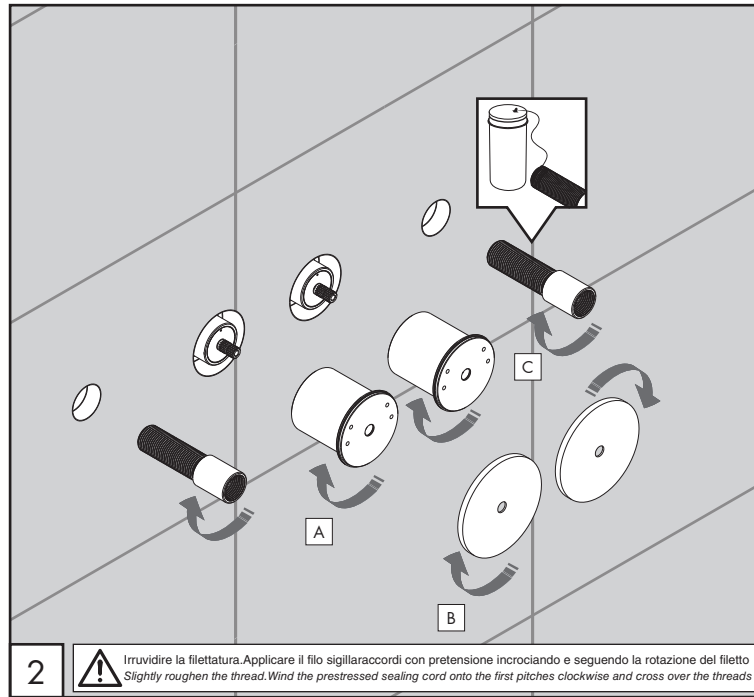
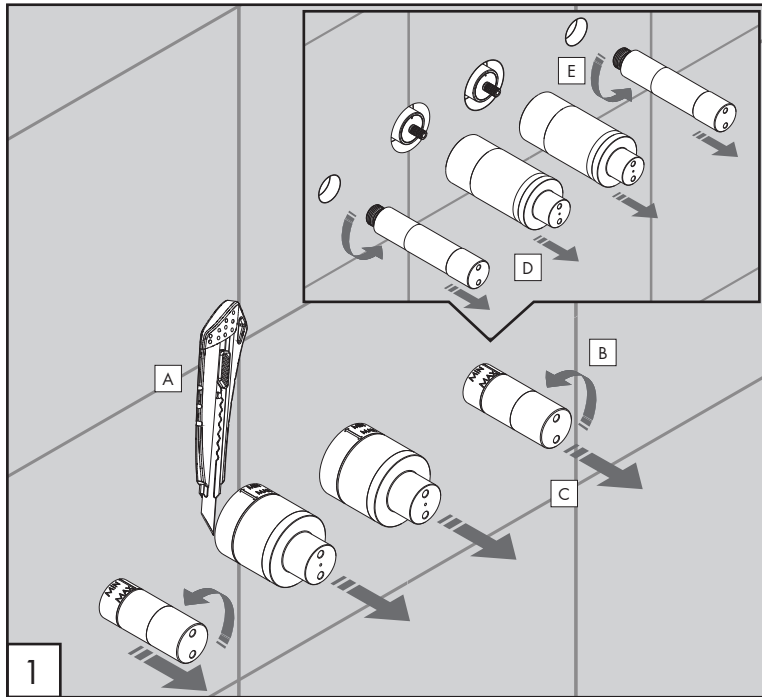

## AVVERTENZE TECNICHE

Risciacquare bene le tubazioni prima del montaggio ed evitare sbalzi di pressione fra i raccordi d'acqua fredda e d'acqua calda. In caso di pressioni statiche superiori a 5 bar si raccomanda l'installazione di un riduttore di pressione per evitare danni alla cartuccia.

## TECHNICAL WARNINGS

The pipes have to be rinsed thoroughly before installation. Avoid pressure differences between hot and cold water supply. Use of a pressure reducer when static pressure is higher than 5 bar to avoid damage of the cartridge.

## TECHNISCHE WARNUNG

Spülen Sie die Leitungen vor dem Einbau und verhindern Sie Wasserdruckwechsel zwischen kalt und warm Wasserverbindungen. Wenn Wasserdruck größer als 5 bar ist, bitte reduzieren Sie den Systemdruck, um Beschädigung der Kartusche zu verhindern.



## ADVERTENCIA TÉCNICA

Los tubos tienen que ser enjuagados a fondo antes de la instalación. Evitar grandes diferencias de presión entre las conexiones de agua caliente y fría. En caso de presión estática mayor de 5 bar, se recomienda el uso de un adaptador de presión para evitar daños en el cartucho.

## ADVERTISSEMENTS TECHNIQUES

Rincer les tuyaux avant l'installation. Eviter des grandes différences de pression entre l'eau froide et chaude. En cas de pressions statique de plus de 5 bar, nous vous recommandons d'installer un réducteur de pression pour éviter des dommages à la cartouche.

## TEMPERATURA DI ESERCIZIO / WORKING TEMPERATURE

 max. 70 °C  
 max. 158 °F

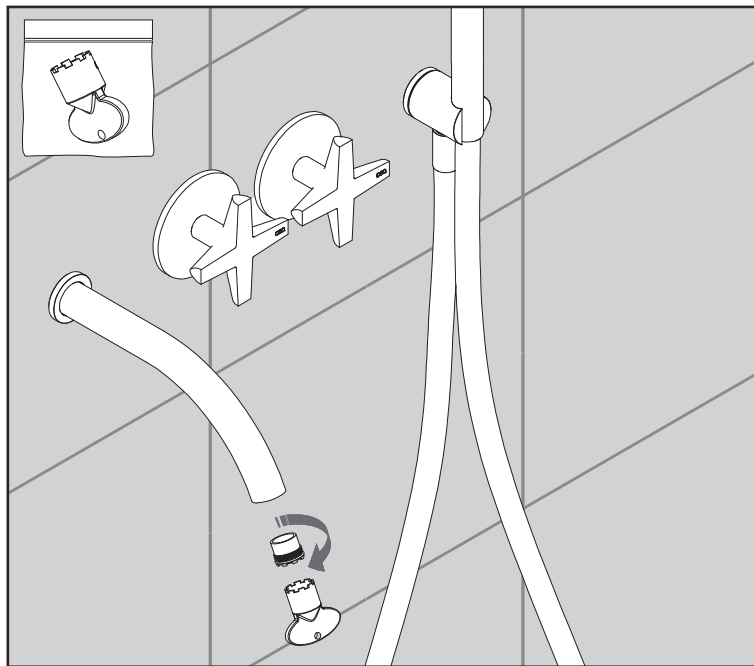
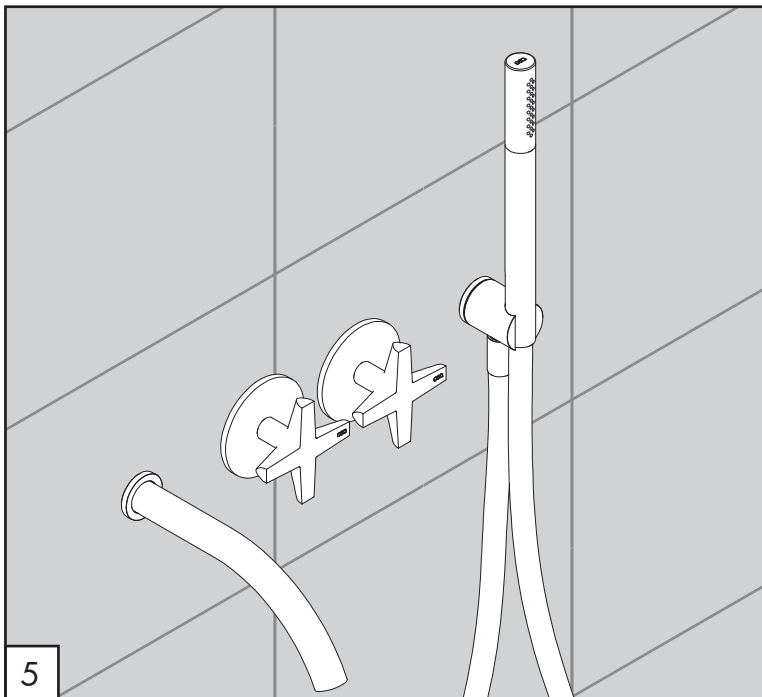

CRX23 \_REV14



Le portate indicate sono alla pressione consigliata di 3 bar  
*The indicated flow rates are at the recommended pressure of 3 bar*

PORTATE DOCCINO / HAND SHOWER FLOW RATE

Acciaio inox / *Stainless steel*

14,7 l/min / 3.9 gpm

Gomma siliconica / *Silicone rubber*

11,4 l/min / 3 gpm

AERATORE IN DOTAZIONE / AERATOR INCLUDED



Rompi-getto a flusso libero / *Free flow aerator*

(23,2 l/min / 6.1 gpm)

CEA

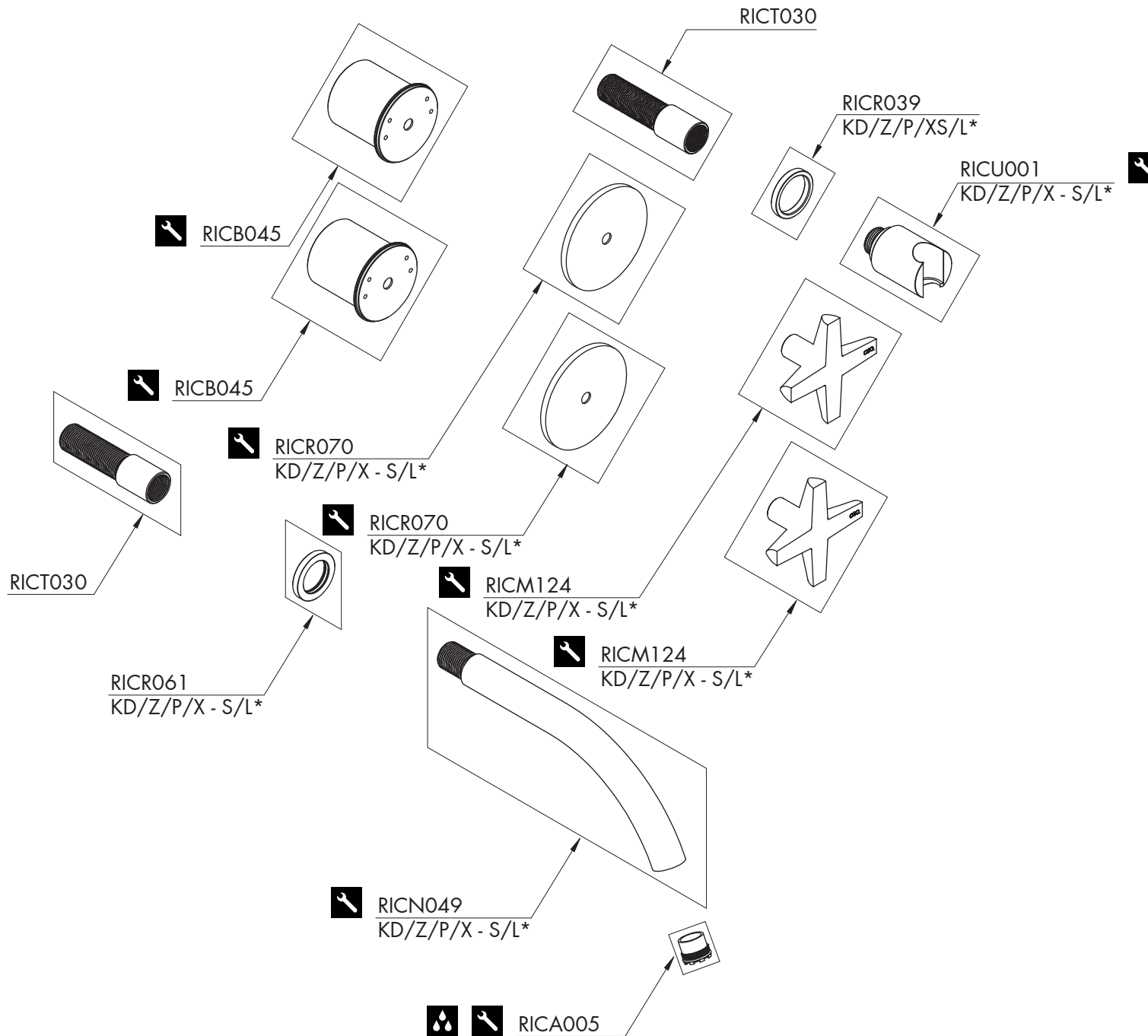

## RICAMBI / SPARE PARTS

RICA005	Rompi-getto a flusso libero / <i>Free flow aerator</i> (23,2 l/min / 6.1 gpm)
RICB045	Carter / <i>Carter</i>
RICM124	Maniglia / <i>Handle</i>
RICN049	Bocca di erogazione / <i>Spout</i>
RICR039	Rosetta / <i>Rosette</i>
RICR061	Rosetta / <i>Rosette</i>
RICR070	Rosetta / <i>Rosette</i>
RICT030	Raccordo / <i>Fitting</i>
RICU001	Supporto doccia / <i>Hand shower holder</i>

## LEGENDA / LEGEND

### ICONE / ICONS

- Rompi-getto, utilizzabile per il riempimento vasca  
*Flow straightener, suitable for bathtub*
- Utensile incluso nel ricambio  
*Tool included in spare part*

### FINITURE / FINISHES

- \*S finitura satinata / *satn finish*
- L finitura lucidata / *polished finish*

### FINITURE SPECIALI / SPECIAL FINISHES

- KD black diamond
- Z bronzo / *bronze*
- P rame / *copper*
- X light gold

### COLORI FLESSIBILE / HOSE COLOURS

A	verde acqua / <i>aqua green</i>	RAL 6027
B	blu cobalto / <i>cobalt blue</i>	RAL 5013
G	grigio antracite / <i>anthracite grey</i>	RAL 7043
W	bianco / <i>white</i>	RAL 9016
SG	grigio seta / <i>silk grey</i>	RAL 7044
PG	verde petrolio / <i>petroleum green</i>	RAL 5020
BK	nero / <i>black</i>	RAL 9004
AB	blu avio / <i>air force blue</i>	RAL 5014
DB	grigio quarzo / <i>quartz grey</i>	RAL 7039
I	acciaio inox / <i>stainless steel</i>	

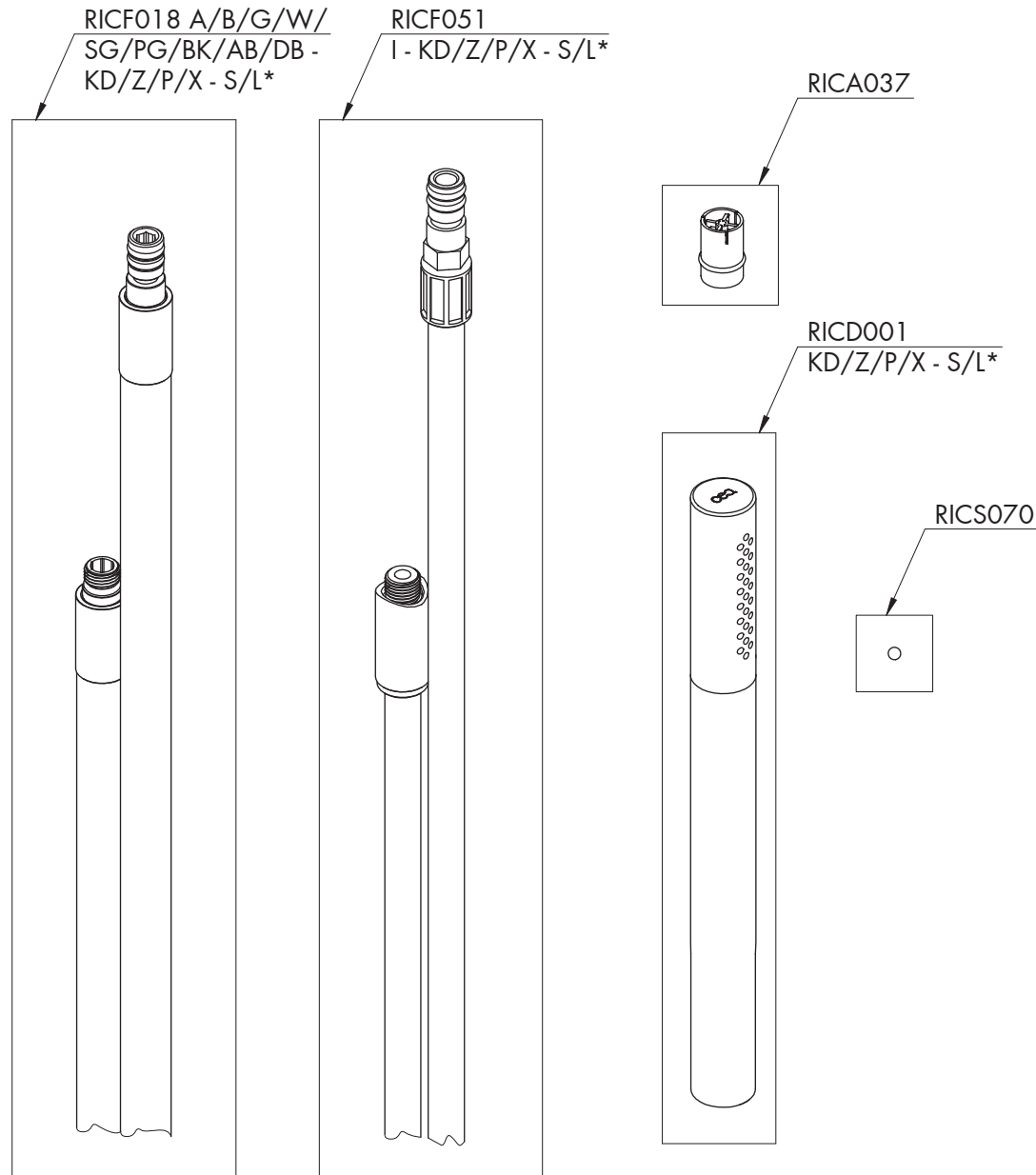

## RICAMBI / SPARE PARTS

RICA037	Valvola di non ritorno / <i>Check valve</i>
RICD001	Doccino / <i>Hand shower</i>
RICF018	Flessibile / <i>Hose</i>
RICF051	Flessibile / <i>Hose</i>
RICS070	Sfera in acciaio inox Ø 3,5 mm <i>Stainless steel ball Ø 3,5 mm</i>

## LEGENDA / LEGEND

### ICONE / ICONS

 Utensile incluso nel ricambio  
*Tool included in spare part*

### FINITURE / FINISHES

\*S finitura satinata / *satin finish*  
L finitura lucidata / *polished finish*

### FINITURE SPECIALI / SPECIAL FINISHES

KD black diamond  
Z bronzo / *bronze*  
P rame / *copper*  
X light gold

### COLORI FLESSIBILE / HOSE COLOURS

A	verde acqua / <i>aqua green</i>	RAL 6027
B	blu cobalto / <i>cobalt blue</i>	RAL 5013
G	grigio antracite / <i>anthracite grey</i>	RAL 7043
W	bianco / <i>white</i>	RAL 9016
SG	grigio seta / <i>silk grey</i>	RAL 7044
PG	verde petrolio / <i>petroleum green</i>	RAL 5020
BK	nero / <i>black</i>	RAL 9004
AB	blu avio / <i>air force blue</i>	RAL 5014
DB	grigio quarzo / <i>quartz grey</i>	RAL 7039
I	acciaio inox / <i>stainless steel</i>	